

MATERIAL PROCESSING



CONTENT

- . Drilling/ Chiselling**
- . Countersinking/Milling/Tapping**
- . Cutting/ Grinding/Sanding/ Polishing**
- . Sawing**
- . General**

DRILL BITS

Würth Line Twist Drill Bit

Art. No. 00617 000...

Assembly drill for general, broad applications in steel up to 850 N/mm² strength and cast iron.

Quick drilling
Self-centring

GOOD



ZEBRA HSS TWIST DRILL BIT

Art. No. 00624 000...

Steel precision drill for general, broad applications in steel up to 850 N/mm² strength and cast iron.

- 20% lower feed force compared with conventional drill bits, faster working progress and less-fatiguing.
- Extremely accurate tapping without centring, even on domed surfaces.
- Ideal for core hole drilling
- Excellent adhesive properties of cooling lubricants and reduced tendency towards the build-up of material deposits



BETTER

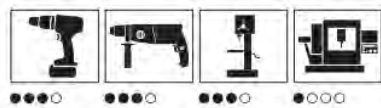

TIN Head Twist Drill Bit

Art. No. 00624 020...

TiN head coated steel precision drill for general, broad applications in steel up to 850 N/mm² strength and cast iron.

Precise & Quick drilling
Self-centring

Long tool life

The TiN coating increase the heat resistance up to 600°, which provides 3 times more tool life in comparison with a non-coated HSS drill.



BEST





	GOOD	BETTER	BEST
	Wurth Line Drill Bits	Zebra Drill Bits	Zebra TiN Drill Bits
1 - 10 mm set	00617 000 001	00624 000 001	00624 020 001
1 - 13 mm set	*	00624 000 002	*
0.5 mm	*	00624 000 050	*
1.0 mm	00617 000 100	00624 000 100	00624 020 100
1.2 mm	*	00624 000 120	*
1.5 mm	00617 000 150	00624 000 150	00624 020 150
1.7 mm	*	00624 000 170	*
2.0 mm	00617 000 200	00624 000 200	00624 020 200
2.3 mm	*	00624 000 230	*
2.5 mm	00617 000 250	00624 000 250	00624 020 250
2.8 mm	*	00624 000 280	00624 020 280
3.0 mm	00617 000 300	00624 000 300	00624 020 300
3.2 mm	00617 000 320	00624 000 320	00624 020 320
3.3 mm	*	00624 000 330	00624 020 330
3.5 mm	00617 000 350	00624 000 350	00624 020 350
3.8 mm	*	00624 000 380	00624 020 380
4.0 mm	00617 000 400	00624 000 400	00624 020 400
4.1 mm	*	00624 000 410	00624 020 410
4.2 mm	00617 000 420	00624 000 420	00624 020 420
4.5 mm	00617 000 450	00624 000 450	00624 020 450
4.8 mm	00617 000 480	00624 000 480	00624 020 480
4.9 mm	*	00624 000 490	00624 020 490
5.0 mm	00617 000 500	00624 000 500	00624 020 500
5.3 mm	*	00624 000 530	00624 020 530
5.5 mm	00617 000 550	00624 000 550	00624 020 550
6.0 mm	00617 000 600	00624 000 600	00624 020 600
6.2 mm	*	00624 000 620	00624 020 620
6.4 mm	*	00624 000 640	00624 020 640
6.5 mm	00617 000 650	00624 000 650	00624 020 650
6.8 mm	*	00624 000 680	00624 020 680
7.0 mm	00617 000 700	00624 000 700	00624 020 700
7.5 mm	00617 000 750	00624 000 750	00624 020 750
8.0 mm	00617 000 800	00624 000 800	00624 020 800
8.5 mm	00617 000 850	00624 000 850	00624 020 850
8.7 mm	*	00624 000 870	*
9.0 mm	00617 000 900	00624 000 900	00624 020 900
9.5 mm	00617 000 950	00624 000 950	00624 020 950
10.0 mm	00617 001 000	00624 001 000	00624 021 000
10.2 mm	*	00624 001 020	00624 021 020
10.5 mm	00617 001 050	00624 001 050	00624 021 050
11.0 mm	00617 001 100	00624 001 100	00624 021 100
11.5 mm	00617 001 150	00624 001 150	00624 021 150
12.0 mm	00617 001 200	00624 001 200	00624 021 200
12.5 mm	00617 001 250	00624 001 250	00624 021 250
13.0 mm	00617 001 300	00624 001 300	00624 021 300
14.0 mm	00617 001 400	00624 001 400	00624 021 400
15.0 mm	00617 001 500	*	*
16.0 mm	00617 001 600	00624 001 600	00624 021 600
18.0 mm	00617 001 800	*	*
20.0 mm	00617 002 000	*	*

ZEBRA HSCO TWIST DRILL BIT (STAINLESS STEEL)

The precise high-performance drill for processing stainless steel, heat-resistant steels and titanium. Also suitable for general broader applications in steel with strength up to 1000 N/mm and in cast iron.

- Rapid drilling with perfect chip removal
- Large chipping spaces and small core
- Ideal for producing core drill holes
- Highly precise tip for precise drilling

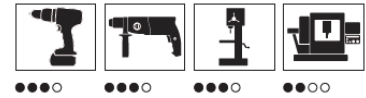

Note

The drill shank is turned from the 13.0 mm dia. to a 12.7 mm dia.

Material	Steel, cast iron, stainless steel, titanium
Standard	DIN 338
Shank Style	Cylindrical
Surface	Oxide finish
Cutting material	HSCO
Tip angle	130 degrees
Tool life	3/4
Drilling speed	3/4
Drill hole quality	4/4
Versatility	3/4
Drilling behaviour	3/4
Self centring	Yes

Diameter (mm)	Length (mm)	Art No
1.0	34	00626 000 100
1.5	40	00626 000 150
2.0	49	00626 000 200
2.5	57	00626 000 250
3.0	61	00626 000 300
3.5	70	00626 000 350
4.0	75	00626 000 400
4.2	75	00626 000 420
4.5	80	00626 000 450
4.9	86	00626 000 490
5.0	86	00626 000 500
5.5	93	00626 000 550
6.0	93	00626 000 600
6.5	101	00626 000 650
7.0	109	00626 000 700
7.5	109	00626 000 750
8.0	117	00626 000 800
8.5	117	00626 000 850
9.0	125	00626 000 900
9.5	125	00626 000 950
10.0	133	00626 001 000
12.0	151	00626 001 200
14.0	160	00626 001 400

DRILL BITS

Multi Purpose Drill

Rotary drilling in tiles, solid bricks, roof tiles, cavity bricks, stone, marble, wood, plastic, metal etc.

Extra-sharp carbide cutting edges with special diamond grinding on all sides



- Clean and precise holes, even when drilling alternately in different materials
- Suitable for universal use
- Shatter-proof drilling of hollow-chamber bricks
- Highly precise spot drilling
- Outstanding drilling results in metal

Art. No.	Size
00641 206 010	Zebra Multi HM Drill 6 x 100
00641 208 012	Zebra Multi HM Drill 8 x 120

PGM tested

Suitable for drilling holes intended for anchor connections that are subject to approval

NOTICE

Not suitable for impact drilling. For rotary drilling only



Zebra Masonry Drill

Impact drilling in concrete, masonry, sand-lime brick and natural stone. Also for rotary drilling in ceramic and marble.

High - performance impact drill bit with the features of a hammer drill



Hammer-resistant, extremely robust and designed for the toughest applications

- State-of-the-art vacuum hardening
- Highly resilient cemented carbide tip
- Optimum soldering using high-vacuum technology, heat-resistant up to 1100°C
- Specially quenched and tempered clamping shank
- High-strength drill bit head, same shank material as the hammer drill bit

Fast drilling progress

Aggressively ground cemented carbide plate
Multi-spiral, large-volume spiral conveyor
Suitable for rotary and impact drilling
Special cemented carbide tip geometry

PGM tested

Suitable for drilling holes intended for anchor connections that are subject to approval.

Size	Art. No.
Zebra Masonry Drill Bit M10.0 X 120	00637 201 012
Zebra Masonry Drill Bit M12.0 X 150	00637 201 215
Zebra Masonry Drill Bit M14.0 X 150	00637 201 415
Zebra Masonry Drill Bit M15.0 X 150	00637 201 515
Zebra Masonry Drill Bit M4.0 X 75	00637 204 007
Zebra Masonry Drill Bit M5.0 X 85	00637 205 008
Zebra Masonry Drill Bit M6.0 X 100	00637 206 010
Zebra Masonry Drill Bit M7.0 X 110	00637 207 010
Zebra Masonry Drill Bit M8.0 X 120	00637 208 012

DOUBLE ENDED DRILL BITS

Assembly drill bit for working in thin sheet steel with a tip angle of 130 degrees.

- Highly precise drilling
- The robust twist drill with its extra short design ensures highly precise drilling
- Self-centring
- The split point ensures an excellent centring effect even on round materials eliminating the need for centre-punching or piloting

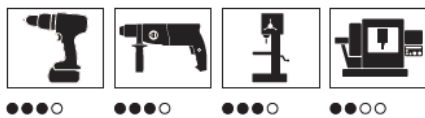

Steel

Diameter (mm)	Length (mm)	Art No
2.0	38	00636 20
2.5	43	00636 25
3.0	46	00636 30
3.2	49	00636 32
3.3	49	00636 33
3.5	52	00636 35
4.0	55	00636 40
4.1	55	00636 41
4.2	55	00636 42
4.5	58	00636 45
5.0	62	00636 50
5.2	62	00636 52
5.5	66	00636 55
6.0	66	00636 60

FORSTNER BITS

Forstner bits are guided by the wide outside rim of the bit, unlike most drill bits, which are guided by the tip. Because of that, they can be used along with a drill press to drill angled holes, holes that partially overlap, and holes on the edge of the material.



Art.No.	Diameter	Shaft Diameter	Length	Shaft Length
00650 001 12	12mm	6mm	90mm	30mm
00650 001 15	15mm	8mm	90mm	30mm
00650 001 20	20mm	8mm	90mm	30mm
00650 001 25	25mm	8mm	90mm	30mm
00650 001 30	30mm	8mm	90mm	30mm
00650 001 35	35mm	10mm	90mm	30mm

SDS-PLUS QUADRO DRILLS

The perfect solution for reinforcements and hard materials, featuring a symmetrical, one-piece head with four cutting edges and a four-spiral Vario feed helix with core reinforcement.

Art. No. 00648 05...



Significantly improved compatibility with reinforcements

The symmetrical 4 x 90° cutting edge geometry (up to Ø 10 mm with solid carbide head) prevents the drill bit from hooking in or running off centre when striking e.g. reinforcements.

Noticeably quicker drilling

The advanced tip geometry and asymmetrically placed elevations on the cutting edges ensure improved traction.

Perfect drilling properties over the entire service life

- Head geometry that is tailored to the drill bit diameter
- 5-16 mm: One-piece carbide element – maximised attachment surface with the steel body gives high stability.
- 18-32 mm: Multi-piece carbide element for faster drilling progress, and trisection design to improve buffering of torsional forces.

Considerably improved drilling speed and dust removal while at the same time offering increased protection against breakage

Vario spiral conveyor with back that narrows at the front and widens at the rear, as well as sharper angle at the spiral end ensures reduced friction, high stability and maximum transmission of impact energy.

Notice

Iron reinforcements may only be drilled through with permission from a structural engineer. With long drill bit lengths, pre-drill using a short drill bit of the same diameter.



- **Prüfgemeinschaft Mauerbohrer (PGM)**
- Registered organization located in Remscheid (Germany), founded in 1978
- Only **manufacturers** can become a member and **not dealers, importers or private labels**
- 14 drill bit worldwide manufacturers are members
- Organization:
 - **Managing Committee:** strategic matters
 - **Steering Committee with involvement of the anchor manufacturers:** decisions concerning certifications, development of the certification rules, basic examinations concerning the influence of the drill bit on the safety of anchor fixings
 - **Office:** organisational matters
- Approved by certification bodies for anchors

SDS-PLUS PERCUSSION DRILLS

Art. No. 00648 33...

Art. No. 00648 55...

Rugged hammer drill bit featuring an "aggressive" head with two cutting edges, centering tip and a core-strengthened Vario feed helix for noticeably improved drilling speed. Specially optimized for battery-operated hammer drills

Noticeably faster drilling

Optimized tip geometry and asymmetrically arranged protrusions on the cutting edges provide for improved drilling progress.

Optimized drilling behaviour when hitting reinforcement

Strengthened carbide element with considerably enlarged reinforcement chamfers greatly reduces the probability of catching when hitting reinforcement and also increases durability.



-  The new DUO-S VARIO drill bit sets new performance standards.
-  It is the consequent further development of the over one million sold 4 PLUS drill bits.
-  In terms of drilling speed the new DUO-S VARIO drill bit is up to 12% faster than the 4 PLUS drill bit and up to 25% faster than the competition.
-  Ideal for use with cordless hammers.
-  This proves the DUO-S VARIO drill bit will inspire and convince users of its "Made in Germany" qualities and it will be the most outstanding drill bit of this next generation.

SDS-PLUS QUADRO DRILLS



Art. No.	Size
00648 051 016	SDS PLUS QUADRO DRILL BIT M10X165MM
00648 051 021	SDS PLUS QUADRO DRILL BIT M10X215MM
00648 051 031	SDS PLUS QUADRO DRILL BIT M10X215MM
00648 051 216	SDS PLUS QUADRO DRILL BIT M12X160MM
00648 051 221	SDS PLUS QUADRO DRILL BIT M12X210MM
00648 051 226	SDS PLUS QUADRO DRILL BIT M12X260MM
00648 051 421	SDS PLUS QUADRO DRILL BIT M14X210MM
00648 051 431	SDS PLUS QUADRO DRILL BIT M14X310MM
00648 051 621	SDS PLUS QUADRO DRILL BIT M16X210MM
00648 051 626	SDS PLUS QUADRO DRILL BIT M16X260MM
00648 051 845	SDS PLUS QUADRO DRILL BIT M18X450MM
00648 052 025	SDS PLUS QUADRO DRILL BIT M20X250MM
00648 052 045	SDS PLUS QUADRO DRILL BIT M20X450MM
00648 052 225	SDS PLUS QUADRO DRILL BIT M22X250MM
00648 052 245	SDS PLUS QUADRO DRILL BIT M22X450MM
00648 052 425	SDS PLUS QUADRO DRILL BIT M24X250MM
00648 052 445	SDS PLUS QUADRO DRILL BIT M24X450MM
00648 055 011	SDS PLUS QUADRO DRILL BIT M5X155MM
00648 055 016	SDS PLUS QUADRO DRILL BIT M5X165MM
00648 056 011	SDS PLUS QUADRO DRILL BIT M6X115MM
00648 056 016	SDS PLUS QUADRO DRILL BIT M6X165MM
00648 056 026	SDS PLUS QUADRO DRILL BIT M6X265MM
00648 058 016	SDS PLUS QUADRO DRILL BIT M8X165MM
00648 058 026	SDS PLUS QUADRO DRILL BIT M8X 265MMK

SDS-PLUS PERCUSSION DRILLS



Art. No.	Size.
00648 331 031	PERCUSSION DRILL SDS-PLUS M10X310MM
00648 551 016	PERCUSSION DRILL SDS-PLUS M10X160MM
00648 551 021	PERCUSSION DRILL SDS-PLUS M10X120MM
00648 551 216	PERCUSSION DRILL SDS-PLUS M12X160MM
00648 551 221	PERCUSSION DRILL SDS-PLUS M12X210MM
00648 551 226	PERCUSSION DRILL SDS-PLUS M12X260MM
00648 551 421	PERCUSSION DRILL SDS-PLUS M14X210MM
00648 551 431	PERCUSSION DRILL SDS-PLUS M14X310MM
00648 551 621	PERCUSSION DRILL SDS-PLUS M16X210MM
00648 551 626	PERCUSSION DRILL SDS-PLUS M16X260MM
00648 551 820	PERCUSSION DRILL SDS-PLUS M18X200MM
00648 551 845	PERCUSSION DRILL SDS-PLUS M18X450MM
00648 552 020	PERCUSSION DRILL SDS-PLUS M20X200MM
00648 552 030	PERCUSSION DRILL SDS-PLUS M20X300MM
00648 552 045	PERCUSSION DRILL SDS-PLUS M20X450MM
00648 552 225	PERCUSSION DRILL SDS-PLUS M22X250MM
00648 552 445	PERCUSSION DRILL SDS-PLUS M24X450MM
00648 555 011	PERCUSSION DRILL SDS-PLUS M5X110MM
00648 555 016	PERCUSSION DRILL SDS-PLUS M5 X160MM
00648 556 011	PERCUSSION DRILL SDS-PLUS M6X110MM
00648 556 016	PERCUSSION DRILL SDS-PLUS M6X160MM
00648 556 026	PERCUSSION DRILL SDS-PLUS M6X260MM
00648 558 016	PERCUSSION DRILL SDS-PLUS M8X160MM
00648 558 026	PERCUSSION DRILL SDS-PLUS M8X260MM

DRILL SETS

Würth Line Drill Bits

Art. No. 00617 000 001
19-piece
contents: 1.0 - 10.0x0.5mm



Zebra stone Drill Set 4-12MM

Art. No 00637 200 001



Zebra Drill Bits

Art. No. 00624 000 001
19-piece
contents: 1.0 - 10.0x0.5mm dia



SDS Plus Quadro Drill Set, 7Pcs

Art. No 00648 050 001



Zebra Tin Drill Bits

Art. No. 00624 020 001
19-piece
contents: 1.0 - 10.0x0.5mm dia



Burr Set, 10Pcs

Art. No 00616 100



55 pieces steel precision drill bits for general, broad applications in steel up to 850 N/mm² strength and cast iron.

Zebra Twist drill SET, **55 pieces**

Art. No. 00624 000 002



SPOT WELD DRILL HSCO

For simple removal of spot weld—can be used in a normal drill machine



Diameter	Length	Art. No.
6mm	65mm	00710 006
8mm	78mm	00710 008

Long cutting life thanks to HSCO material

Maximum speed:

for $\varnothing 6$: up to 1,100rpm

for $\varnothing 8$: up to 850 rpm

SPOT WELD DRILL HSCO

For simple removal of spot weld - for use in Vario drills

***No need to centre punch**



Diameter	Length	Art No.
6mm	44.7mm	00710 60
8mm	44.7mm	00710 80
9mm	44.7mm	00710 90

SPOT WELD MILLING CUTTER



Art No. 00698 1 - **Complete cutter**

Art No. 00698 1 - **Spare Blades**



Efficient and fast

- The milling depth can be adjusted via the adjustment screw
- Rasp can be used on both sides
- No fraying of the sheet metal

WOOD DRILLING - PROCESSING

For hardwood, wood and plastics. Optimum centring and chip removal



With a precision-ground centring point with two pre-cutters
Optimum centring for outstanding drilled hole quality

Special groove geometry and double bevel
Optimum chip removal and stable drilling

Extremely low manufacturing tolerances with precisely defined surface and profile quality
More accurate drilling behaviour

Blade-like ground cutting edges
Rapid and accurate drilling

Double bevel
Prevents any deviation in diameter (no off-centre drilling)

Art. No.	
00650 410	10mm
00650 43	3mm
00650 44	4mm
00650 47	7mm

PUSH - ON COUNTERSINK

For Wood Twist Drills



Art. No.	Size
00650 74	Countersink attachment 4mm
00650 75	Countersink attachment 5mm
00650 78	Countersink attachment 8mm

Application example



ZEBRA STEP DRILL

Extremely versatile and fast spiral stepped drill bits with an exceptionally long tool life

Size	Part No.
4 to 12mm	00694 423 412
4 to 20mm	00694 423 420
4 to 30mm Titan	00694 423 630



Precise drilling

Self-centering drilling tip.

Up to 30% faster

In comparison with competitor products thanks to optimally aligned cutting edge geometry.

Up to double the tool life

In comparison with competitor products thanks to reduction of wear on the drilling tip and the main cutting edges, as well as on the radial and axial relief grind.

No slippage in the drill chuck

Three-face shank and 1/4" bit holder.

Precise working

Laser-inscribed diameters in both spiral grooves.

Hardly any reworking necessary

Precise, circular drilling holes.

Especially suitable for stainless steel drilling

SLUGGER BITS

High performance and rapid drilling progress with a long service life

No pre drilling required, no formation of burrs

Optimised cutting geometry

Long service life compared to many standard core drill bits

Clean drill profile

Drill hole with precise tolerances



Part Number	Size
00630 930 120	Core drill bit 12mm
00630 930 140	Core Drill Bit 14mm
00630 930 160	Core Drill Bit 16mm
00630 930 180	Core Drill Bit 18mm
00630 930 200	Core Drill Bit 20mm
00630 930 220	Core Drill Bit 22mm
00630 930 240	Core Drill Bit 24mm
00630 930 260	Core Drill Bit 26mm

SDS - MAX CHISELS (For use with 10kg Hammer Chisel 00702 571 1)

Flat Chisel

Art. No 00647 040 025
Length 400mm, Width 25mm

Art. No. 00647 060 025
Length 600mm, Width 25mm



Pointed Mortise Chisel

Art. No 00647 040 0
Length 400mm



Spade Chisel

Art. No 00647 853 115
Length 350mm, Width 115mm



Pointed Mortise Chisel

Art. No 00647 851 280
Length 280mm



Spade Chisel

Art. No 00647 853 50
Length 380mm, Width 50mm



Tile Chisel

Art. No 00647 855 50
Length 380mm, Width 50mm



Flat Chisel

Art. No 00647 852 225
Length 280mm, Width 25mm



SDS PLUS CHISELS

Tile Chisel

Art. No 05523 905 240
Length 250mm, Width 40mm



Pointed Chisel

Art. No 05523 901 250
Length 250mm



Flat Chisel

Art. No 05523 902 220
Length 250mm, Width 20mm



Spade Chisel

Art. No 05523 903 240
Length 250mm, Width 40mm



Gouge Chisel

Art. No 05523 904 222
Length 250mm, Width 22mm



SPADE DRILL

Drill bit for wood, drills up to 10 faster than a standard spade drill



Diameter	Length	Art. No.
10mm	150mm	00650 007 010
12mm	150mm	00650 007 012
14mm	150mm	00650 007 014
16mm	150mm	00650 007 016
18mm	150mm	00650 007 018
20mm	150mm	00650 007 020
22mm	150mm	00650 007 022
25mm	150mm	00650 007 025
26mm	150mm	00650 007 026
30mm	150mm	00650 007 030

Self-propelled threaded tip

Drives itself through the wood very quickly with a minimal application of force

Two cutting edges

Fast penetration of the material with simultaneous high drilled hole quality

Optimum, fast chip removal

Specially curved blade cleans the drilled hole before a tear-out can occur

Hexagon Shank

No slipping of drill in chuck

Application

Medium hardwoods, soft woods, fiberboard, particle board and soft building materials, e.g. gypsum plasterboard

SPADE DRILLS ASSORTMENT

Art. No. 00650 007 004

For wood. 6 pcs. Drills up to 10 times faster than a standard spade drill.

Article Code	00650 007 004
P.Qty	1
Number of parts in assortment/set	6 pieces
Scope of delivery	10.0 12.0 16.0 18.0 20.0 and 25mm dia
Material	Hardened steel





Countersinking

Milling and Tapping

HAND TAPS



Taper, Intermediate and Plug Tap Sets and Assortments for metric ISO threads according to DIN 13.

Art. No. 00639.....Tap Sets (1st,2nd, 3rd Cuts)

Art. No. 00640.....Individual Taps (M3,M4,M5,M6,M8,M10,M12,M14,M16,M20

Art. No. 00639 01.....Tap Set (M3-M12)

HAND TAP CASSETTE HSS DIN 352 21 PIECES M3-M12



21 pieces. For metric ISO thread according to DIN 13

Art. No. 00639 01

DIES



Art. No.	Size
00652 10	DIE CIRCULAR DIN 223 M10X1.5
00652 12	DIE CIRCULAR DIN 223 M12X1.75
00652 12 15	DIE CIRCULAR DIN 223 M12X1.5
00652 14 15	DIE CIRCULAR DIN 223 M14X1.5
00652 5	DIE CIRCULAR DIN 223 M5X0.8
00652 6	DIE CIRCULAR DIN 223 M6X1.0
00652 8	DIE CIRCULAR DIN 223 M8X1.25

TAP WRENCH



Art. No.	Size
00657 1	TAP WRENCH ADJUSTABLE NO.1 M1 -M10
00657 2	TAP WRENCH ADJUSTABLE NO.2 M4-M12
00657 3	TAP WRENCH ADJUSTABLE NO. 3 M5- M21

TAP HANDLES AND ASSORTMENTS

TAP HANDLES



Art. No.	Size
00715 42 01	TAP HOLD/ RATCHET M3-M10 85MM LONG
00715 42 02	TAP HOLD/ RATCHET M5- M12 100MM LONG
00715 4203	TAP HOLD/ RATCHET M3- M10 250MM LONG

DIE WRENCH



Art. No.	Size
00659 2	Die Wrench No. 2 M5 - M6
00659 3	Die Wrench No. 3 M7 - M9
00659 4	Die Wrench No. 4 M10 - M11
00659 5	Die Wrench No. 5 M12 - M14

TAP AND DIE ASSORTMENT

Full assortment for the production of standard metric ISO threads in steel up to 850 N/mm² strength, as well as in cast iron.

Art. No.	Size
05964 065 200	M3 to M12
05964 065 201	M5 to M20



GERMAN
DESIGN
AWARD
WINNER
2018



reddot award 2017
winner

HSS COMBI SCREWS TAPS

Ground precision tool for drilling, thread cutting and countersinking in one step (7 Piece)

Suitable for

Through-holes in steel, non-ferrous metal and plastics material up to 1 x d (M6 = 6 mm material section).
Up to 600 N/mm² tensile strength.

For use in

Drilling machines with right-hand/left-hand rotation, i.e.:

Stationary drilling machines.

Hand drilling machines.

Cordless drilling machines

Art. No. 00653 97...(individual taps)

Art. No. 00653 971... (Complete sets)



Cutting and drilling oil
CUT+COOL

Art.-no.: 00893 050 004



STEEL/STAINLESS STEEL PROCESSING - BURR'S

Cylindrical Type Burr

Art. No. 00616 001 011 - 6 x 18 x 50mm
 Art. No. 00616 001 031 - 9.6 x 19 x 64mm
 (with teeth on end face)



Cylindrical Type Burr

Art. No. 00616 000 000 - 3 x 14 x 38mm
 Art. No. 00616 000 011 - 6 x 18 x 50mm
 Art. No. 00616 000 041 - 12 x 25 x 70mm
 (no teeth on end face)



Cylindrical Tapered Burr

Art. No. 00616 005 041 - 12 x 21 x 66mm



Ball Type Burr

Art. No. 00616 003 000 - 3 x 3 x 38mm
 Art. No. 00616 000 011 - 6 x 14.7 x 50mm



Blunt Tapered Burr

Art. No. 00616 004 011 - 6 x 18 x 50mm
 Art. No. 00616 004 041 - 12 x 25 x 70mm



Cylindrical Round Burr

Art. No. 00616 002 441 - 13 x 25 x 70mm



Cylindrical Round Burr

Art. No. 00616 002 000 - 3 x 14 x 38mm
 Art. No. 00616 002 011 - 6 x 18 x 50mm
 Art. No. 00616 002 031 - 9.6 x 19 x 64mm
 Art. No. 00616 002 041 - 12 x 25 x 70mm

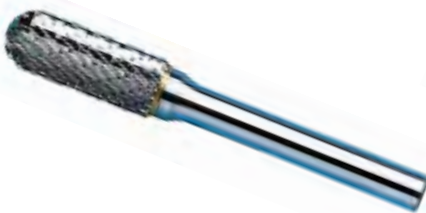

Conical Type Burr

Art. No. 00616 007 000 - 3 x 14 x 38mm
 Art. No. 00616 007 011 - 6 x 18 x 50mm
 Art. No. 00616 007 031 - 9.6 x 19 x 64mm
 Art. No. 00616 007 041 - 12 x 25 x 70mm



Pointed Conical Burr

Art. No. 00616 630 312 - 3 x 12 x 38mm
 Art. No. 00616 008 041 - 12 x 22 x 70mm



Tapered Burr

Art. No. 00616 006 041 - 12 x 30 x 75mm

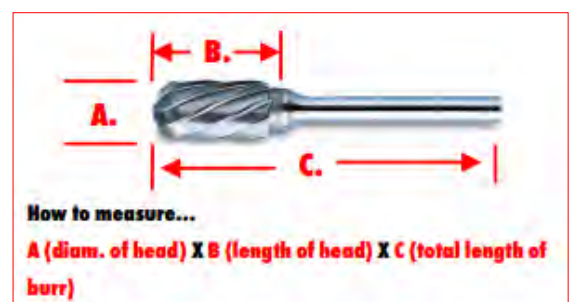

CONICAL COUNTERSUNK STEEL BIT

Designed specifically for processing conventional steels and cast iron

Burr- and chatter-free countersinking and deburring

Precision conical countersink with 3 cutting edges, precision-ground

Optimised flute geometry

Outstanding chip formation and removal



Art No.	Size
00694 017 10	CSK BLUE HHS 10.4MM STEEL
00694 017 12	CSK BLUE HHS 12.4MM STEEL
00694 017 16	CSK BLUE HHS 16.5MM STEEL
00694 017 20	CSK BLUE HHS 20.5MM STEEL
00694 017 25	CSK BLUE HHS 25.5MM STEEL

CONICAL COUNTERSINK ASSORTMENT

6 pieces, consisting of diameters 6.3–20.5 mm. Designed specifically for processing conventional steels and cast iron.

Art. No. 00694 017 01



Burr- and chatter-free countersinking and deburring

Precision conical countersink with 3 cutting edges, precision-ground

Optimised flute geometry

Outstanding chip formation and removal



WOOD PROCESSING - DRILLING



Notice

Not recommended for full countersinking!
Increased service life and cutting performance by using drilling and cutting oil

Conical Countersink

For deburring 90° Countersinks

For chatter-free deburring and countersinking of holes

The even-running cone-envelope relief grinding results in a light, paring cut
The chip flow due to drilling stops chips sticking in the workpiece
Straight shank

Art. No.	Size
00694 021 01	Countersunk Set
00694 021 02	Countersunk with hole 90G HSSE 2- 5 MM WOOD
00694 021 05	Countersunk with hole 90G HSSE 5-10mm WOOD



4-piece assortment for chatter-free deburring and countersinking of holes with the countersink ranges 2/5 mm; 5/10 mm; 10/15 mm; 15/20 mm.



Art. No. 00650 135

Cup Drill 35mm

For machining wood (right-hand movement)

- With centring point
- 2 reaming blades
- 2 pre-cutters
- Short design

STEEL PROCESSING - MOUNTED POINTS (6MM SHAFTS)

Conical Point

Art. No. 00680 21

Head: $\varnothing 20 \times 20$ mm - Grain 30



Round Point

Art. No. 00680 31

Head: $\varnothing 16$ mm - Grain 30



Tapered Point

Art. No. 00680 41

Head: $\varnothing 13 \times 20$ mm - Grain 30



Cyl. Cone Point

Art. No. 00680 51

Head: $\varnothing 20 \times 25$ mm - Grain 30



Cyl. Round Point

Art. No. 00680 61

Head: $\varnothing 20 \times 25$ mm - Grain 30



Cylinder Point

Art. No. 00680 72

Head: $\varnothing 13 \times 20$ mm - Grain 30



Disc Point

Art. No. 00680 73

Head: $\varnothing 20 \times 6$ mm - Grain 46



DRILL AND TAPPING SIZES

ISO METRIC (coarse)		
Tap Size	Pitch	Tapping Drill mm
M2	0.4	1.6
M2.5	0.45	2.05
M3	0.5	2.5
M3.5	0.6	2.9
M4	0.7	3.3
M4.5	0.75	3.7
M5	0.8	4.2
M6	1.0	5.0
M7	1.0	6.0
M8	1.25	6.8
M10	1.5	8.5
M11	1.5	9.5
M12	1.75	10.2
M14	2.0	12.0
M16	2.0	14.0
M18	2.5	15.5
M20	2.5	17.5
M22	2.5	19.5
M24	3.0	21.0
M27	3.0	24.0
M30	3.5	26.5
M33	3.5	29.5
M36	4.0	32.0
M39	4.0	35.0
M42	4.5	37.5
M45	4.5	40.5
M48	5.0	43.0
M52	5.0	47.0

UNC (coarse)		
Tap Size	Pitch	Tapping Drill mm
3(.009)	48	2.0
4(.112)	40	2.25
5(.125)	40	2.6
6(.138)	32	2.75
8(.164)	32	3.4
10(.190)	24	3.8
12(.216)	24	4.4
1/4	20	5.1
5/16	18	6.6
3/8	16	8.0
7/16	14	9.4
1/2	13	10.8
9/16	12	12.2
5/8	11	13.5
3/4	10	16.5
7/8	9	19.5
1"	8	22.0
1 1/8	7	25.0
1-1/4	7	28.0
1-1/2	6	34.0

UNF (fine)		
Tap Size	Pitch	Tapping Drill mm
3(.009)	56	2.1
4(.112)	48	2.35
5(.125)	44	2.65
6(.138)	40	2.9
8(.164)	36	3.5
10(.190)	32	4.1
12(.216)	28	4.6
3/16*	32	4.0
1/4	24	5.5
5/16	24	6.9
3/8	20	8.5
7/16	20	9.8
1/2	18	11.5
9/16	18	12.8
5/8	16	14.5
3/4	14	17.5
7/8	12	20.5
1"	14	23.5
1**	14	24.0
1-1/8	12	26.5
1-1/4	12	29.5
1-1/2	12	36.0

* UNS

SPARK PLUG		
Tap Size	Pitch	Tapping Drill mm
M10	1.0	9.0
M12	1.25	10.8
M14	1.25	12.8
M18	1.5	16.5

METRIC (fine)		
Tap Size	Pitch	Tapping Drill mm
M8	1.0	7.0
M10	1.25	8.8
M12	1.25	10.8
M12	1.5	10.5
M14	1.5	12.5
M16*	1.5	14.5
M18	1.5	16.5
M20*	1.5	18.5
M22	1.5	20.5
M24	2.0	22.0

* Metric Conduit

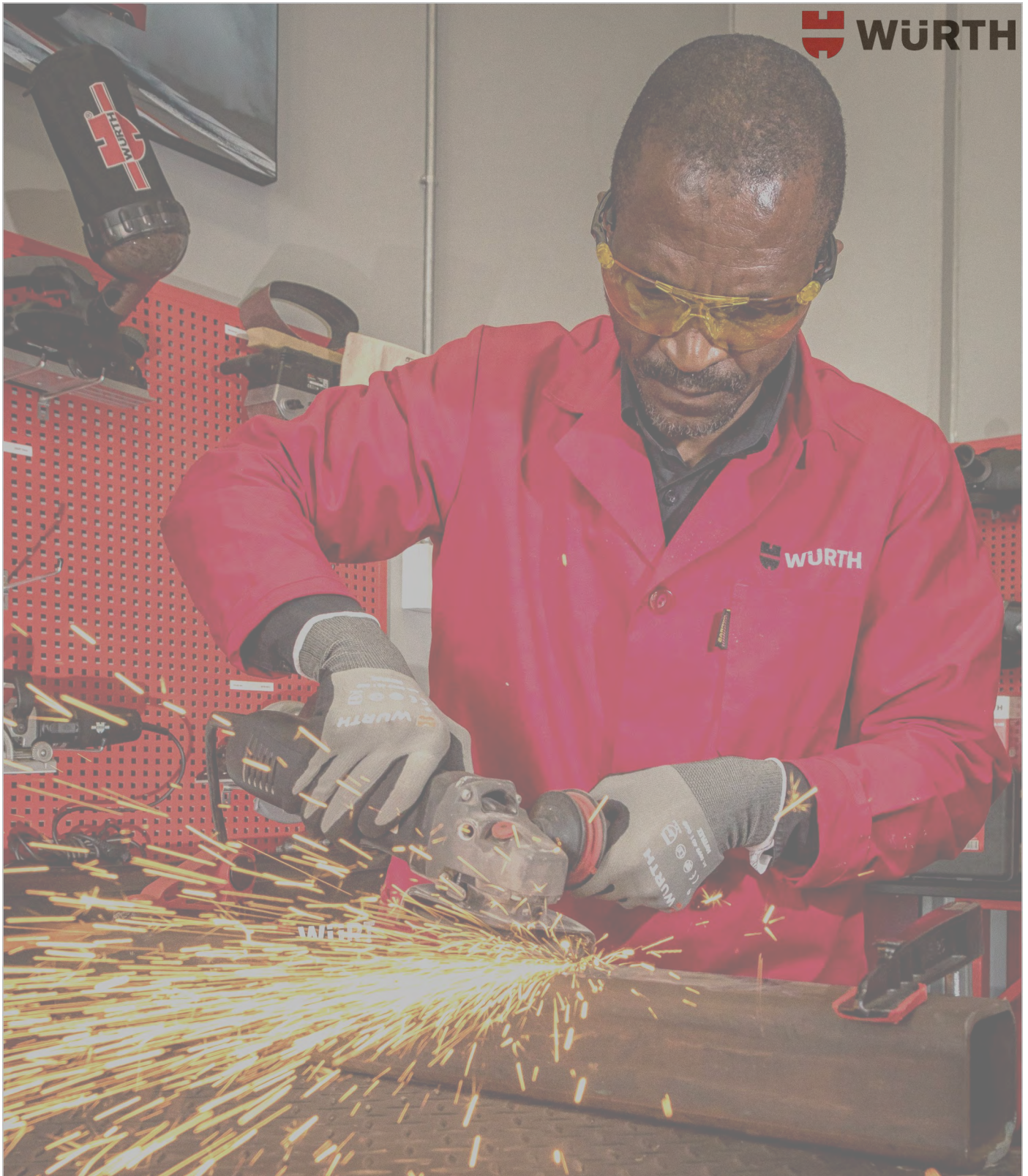

Cutting / Grinding
Sanding / Polishing

CUTTING AND GRINDING

Areas of use	
Materials	Material Designations
Steel 	General construction steels High-strength construction steels Structural steels Tool steels Hardened steels
Non-ferrous metals / Aluminum 	Aluminum Aluminum alloys Copper Brass Bronze Other lubricating non-ferrous metals
Stainless steel 	Stainless-steel sheets Non-alloyed stainless steels Alloyed and high-alloy steels Rust and acid-proof steels Chrome-nickel steel
Stone 	Natural stone Artificial stone Chalky sandstone Concrete/reinforced concrete

General working and safety precautions

- Clearly laid-out and correct storage of wheels dry, at 20 °C room temperature.
- Work only when wearing the appropriate protective clothing such as safety goggles, gloves, steel-capped work shoes, hearing protectors and dust mask.
- Only secure cutting disc and grinding wheels with original clamping flanges provided for this purpose. Do not use defective or worn flanges.
- Only carry out cutting and grinding work with the corresponding protective hood.
- The use of damaged wheels increases the risk of an accident. Only process undamaged wheels.
- The permissible circumferential speed may not be exceeded.
- Do not mount worn wheels on smaller machines.

Clamping Angles

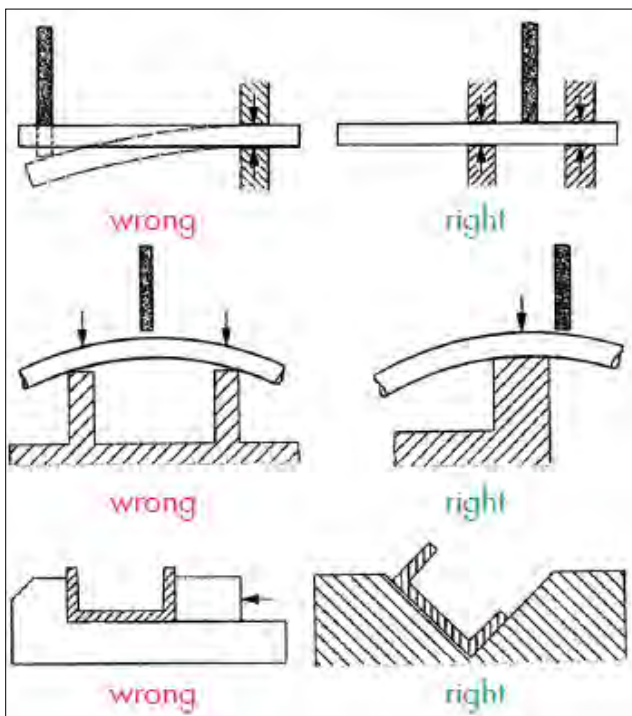

Special working and safety precautions

Cutting

- Cutting discs are not permissible for rough grinding.
- Do not jam or tilt wheels in the cut. Increased risk of breakage!
- A slight pendulum movement in the cut causes the wheel to be cut free.
- Ensure proper contact pressure. The machines own weight is generally sufficient!
- Ensure proper clamping of workpiece.
- Always clamp cutting discs (straight version) with metal ring toward machine.
- For free-hand cutting with electric, pneumatic or battery-powered angle grinders.

Attention

- With cutoff wheels with a thickness of 1.0 mm, it must be checked whether the flange mounting of the angle grinder is suitable for the 1.0 mm wheel. Otherwise firm seating of the wheel must be ensured with the cardboard rings provided for this purpose.

Grinding

- For free-hand grinding with electric, pneumatic or battery-powered angle grinders.
- Ensure the proper contact angle of the grinding wheel. A contact angle which is too flat will cause the wheel to break out around the edge.

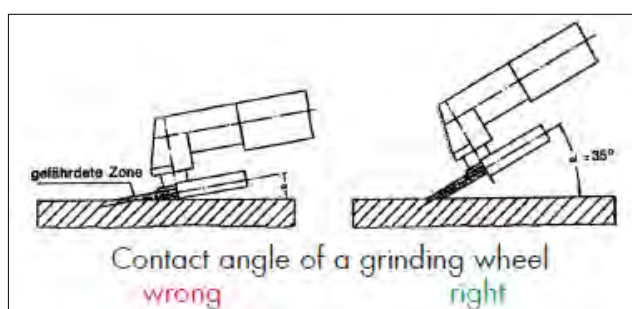

CUTTING AND GRINDING DISC MARKING EXPLAINED....



Expiry Date

WA 60 P8 BF

Abrasive Type....

The abrasive aggregate is selected according to the hardness of the material being cut.

Aluminium oxides are best for steels, while Silicon carbide abrasives are better suited to grinding cast iron, nonferrous metals and non-metallic materials.

- A - Aluminium Oxide
- WA - White Alu. Oxide
- SA - Single Crystal Alu. Oxide

Grit Size....

A relatively coarse grit size is selected for rapid stock removal/cutting—the more coarse the grit, the rougher the finish, and the opposite for finer grits.

Disc Hardness & Density....

The hardness of a disc does not refer to the grit being hard but, more to the overall strength of the disc. The harder the disc the less likely that the grains will be removed from the bonded resin. Simply put, a harder grade disc is better suited to softer materials, and the softer the disc the more suited to harder materials. If a disc that is too hard is used on a hard material there is a risk of the disc glazing over and becoming blunt.

- A to J = Extremely soft to soft.
- K to M = Medium
- N to Z Hard to extremely hard

Bond Types....

There are 2 main types of bonding of relevance, that being Vitrified Bonding (V) or Resinoid Bonding (B). Due to the varying processes of firing, the vitrified bonded disc is more brittle than the Resinoid type. However the Resinoid disc is affected by water and oil, and has a limited shelf life.

- V - Vitrified
- B - Resinoid
- BF - Resin reinforced

The above disc is therefore classified as such:

- Abrasive Type:** White Aluminium Oxide.
- Grit Size:** 60.
- Hardness & Density:** Hard Disc, that is normal in density.
- Bond Type:** Resin reinforced (contains fibreglass as a reinforcement).

ZEBRA CUTTING DISC FOR STAINLESS STEEL



Especially for thin-walled pipes and profiles, thin metal sheets, bodywork panels etc.

- Extreme cutting capacity (very short cutting times) with very long service life.
- Extremely thin for precise, virtually burr and chatter-free cuts (very clean and cool cutting surfaces).
- Very comfortable operation available to protect the user and machine.
- Low cutting waste and dust formation.
- Low noise development and high break resistance.
- Free of iron, chlorine and sulphur ($\leq 0.1\%$).

Proof of Performance

Suitable for KWU Class II (e.g. pipeline and reactor construction).

Meets the maximum safety requirements in accordance with the EN 12413 European standard.

Application area

Stainless steel sheets, non-alloyed stainless steels, alloyed and highly alloyed steels, rust- and acid-proof steels, chrome-nickel steels.

Cutting of pipes, ventilation ducts, metal sheets (e.g. containers, sheet metal constructions), piping, rods, steel reinforcements, profiles and rails (in plumbing sector), cable racks and cable ducts, high-voltage cables, steel cables, composite materials, plastics etc.

Diameter x thickness (mm)	Centre Diameter (mm)	Max RPM	Art. No.
115 x 0.8	22.23	13300	00664 131 148
115 x 1.0	22.23	13300	00664 131 150
125 x 1.0	22.23	12200	00664 131 250
230 x 2.5	22.23	6600	00664 132 302

ADDITIONAL ADVANTAGES OF THIS 0.8MM THIN SHEET METAL PRO

Super thin: The thinnest of the cutting disc. Specially designed for cutting thin sheet metal, e.g. on vehicle bodies, thin-walled pipes, profiles and other thin-walled materials made of steel and stainless steel.

Super fast: Extremely fast cutting - Comparatively quite, low-sparking and with extremely low dust development.

Minimal burr: Cutting with minimal burr information, absolutely precise cut and clearly reduced formation of colour streaks.

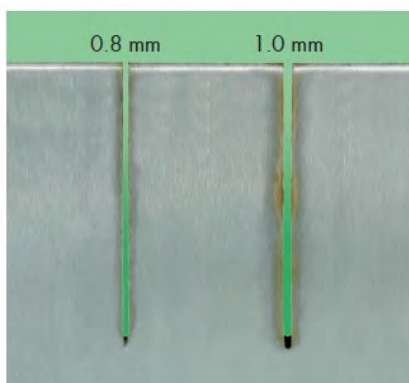

Minimal burr formation with 0.8 mm



For comparison:

Burr formation with common 1.0 mm cutoff wheels



REDLINE CUTTING DISC FOR STAINLESS STEEL



The robust cutting disc with high performance values.

- Optimum cutting capacity with long service life.
- High break resistance.
- Free of iron, chlorine and sulphur ($\leq 0.1\%$).
- Meets the maximum safety requirements in accordance with the EN 12413 European standard.

Application area

Used to cut solid materials, pipes, profiles and stainless steel sheets.

Diameter x thickness (mm)	Centre Diameter (mm)	Max RPM	Art. No.
115 x 1.0	22.23	13300	00669 230 111
125 x 1.0	22.23	12200	00669 230 121
230 x 2.0	22.23	6600	00669 230 231

ZEBRA DUAL GRINDING DISC FOR STEEL AND STAINLESS STEEL

Rough grinding disc with a special multi layer structure for high material removal combined with a long service life.



Free of iron, chlorine and sulphur ($\leq 0.1\%$)

Black fine-grained layer: Support layer (grinding active)

Behaves like a support plate for the coarse grained layer

Increased safety during grinding

No fraying of disc

Wheel grinds down evenly

Excellent vibration dampening

Prevents "white finger disease"

Protects the machine

Grinding-Active layer with specially encased abrasive grain

High grind-off with low contact pressure

Very cool grinding (no material discolouration)

Very clean grinding finish

No clogging (dulling) of disc

Increased work safety thanks to optimum grain adhesion and optimum disc composite

In conjunction with coarse and fine-grained combination, grinding finish can be influenced, e.g. by changing grinding angle or grinding movements

Diameter x thickness (mm)	Centre Diameter (mm)	Art. No.
115 x 6	22.23	00664 181 156
125 x 6.0	22.23	00664 181 256

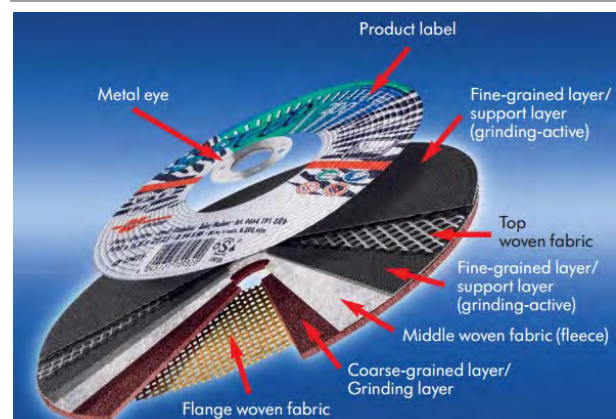

REDLINE FLAPPER DISC FOR STEEL AND STAINLESS STEEL



REDLINE

The robust flap disc with high performance values.

- Optimum grinding capacity with long service life.
- High break resistance.
- Meets the maximum safety requirements in accordance with the EN 12413 European standard.
- Calcined alumina abrasive cloth.
- Glass fabric backing disc.

Diameter (mm)	Centre Diameter (mm)	Max RPM	Grit	Art. No.
115	22.23	13300	40	00579 580 514
115	22.23	13300	60	00579 580 516
115	22.23	13300	80	00579 580 518
115	22.23	13300	120	00579 580 511

Application area

Flap discs for steel/stainless steel. Used to grind edges and surfaces, dressing and smoothing, deburring and for weld seam processing.

FLAPPER DISC FOR STAINLESS STEEL



Zirconia alumina, especially suitable for machining stainless steel.

Properties

- For freehand grinding with electric or pneumatic angle grinders.
- Free of iron, chlorine and sulphur ($\leq 0.1\%$).
- Robust polyester-cotton mixed fabric.
- Glass fabric backing disc.

Abrasive cloth (zirconia alumina)

- Long service life
- High rate of material removal
- Self-sharpening

Application area

Used to grind edges and surfaces, dressing and smoothing, deburring and for weld seam processing.

Stainless steel sheets, non-alloyed special steels, alloyed and high-alloy steels, rust- and acid-proof steels, chrome-nickel steels.

Diameter (mm)	Centre Diameter (mm)	Max RPM	Grit	Art. No.
115	22.23	13300	40	00579 430 314
115	22.23	13300	60	00579 430 316
115	22.23	13300	80	00579 430 318
115	22.23	13300	120	00579 430 311
178	22.23	800	40	00579 430 374
178	22.23	800	60	00579 430 376
178	22.23	800	80	00579 430 378

ZEBRA CUTTING DISC FOR STEEL



Especially for thin-walled pipes and profiles, thin metal sheets, motor vehicle body sheets.

- Extreme cutting capacity (very short cutting times) with very long service life.
- Extremely thin for precise, virtually burr and chatter-free cuts (very clean and cool cutting surfaces).
- Very comfortable operation available to protect the user and machine.
- Low cutting waste and dust formation.
- Low noise development and high break resistance.

Proof of Performance

Meets the maximum safety requirements in accordance with the EN 12413 European standard.

Application area

General construction steels, high-strength construction steels, structural steels, tool steels, hardened steels. Cutting of metal sheets, pipes, profiles, steel cables, armouring iron etc

Diameter x thickness (mm)	Centre Diameter (mm)	Max RPM	Art. No.
115 x 1.0	22.23	13300	00664 101 150
125 x 1.0	22.23	12200	00664 101 250
230 x 2.0	22.23	6600	00664 102 302

REDLINE CUTTING DISC FOR STEEL



The robust cutting disc with high performance values.

- Optimum cutting capacity with long service life.
- High break resistance.
- Meets the maximum safety requirements in accordance with the EN 12413 European standard.

Application area

Used to cut solid materials, pipes, profiles and metal sheets.

Diameter x thickness (mm)	Centre Diameter (mm)	Max RPM	Art. No.
115 x 1.0	22.23	13300	00669 201 155
125 x 1.0	22.23	12200	00669 201 255
230 x 3.0	22.23	6600	00669 202 303
350 x 2.5	25.4	4400	00669 203 502

REDLINE GRINDING DISC FOR STEEL



The robust grinding wheel with high performance values.

- Optimum grinding capacity with long service life.
- High break resistance.
- Meets the maximum safety requirements in accordance with the EN 12413 European standard.

Application area

Used to grind edges, weld seams and surfaces.

REDLINE

Diameter x thickness (mm)	Centre Diameter (mm)	Max RPM	Art. No.
115 x 6.0	22.23	13300	00669 260 116
125 x 6.0	22.23	12250	00669 260 126
230 x 6.0	22.23	6650	00669 260 236

GRINDING DISC FOR STEEL



Especially long service life combined with high removal rates.

- Synthetic resin-bonded, fibre-reinforced high-performance roughing wheels
- For freehand grinding with electric or pneumatic angle grinders
- Extremely low susceptibility to breakage
- Minimal dimension and imbalance tolerances

Diameter x thickness (mm)	Centre diameter	Max rpm	Art. No.
115x 6	22.23mm	13300	00670 161 157
180 x 6	22.23mm	8500	00670 161 808
230 x 6	22.23mm	6600	00670 162 308

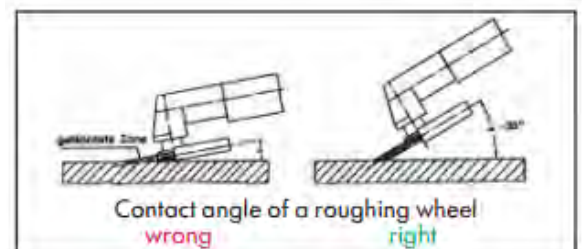

REDLINE NYLON FLEECE SANDING DISC

For universal use on virtually all materials. Especially for stainless steel, steel, non-ferrous metals, wood and plastic.

Coarsely structured, elastic, abrasive cleaning sanding fleece made of synthetic fibres, for direct use on angle grinders.

Application area

- Cleaning welding seams, metal surfaces, wood and plastic.
- Removing tempering colour, scale, rust, corrosion, dirt and oxide layers, coatings, paints, old brushed-on coatings, synthetic resins, adhesives, gasket residues, cement and concrete residues.
- Structuring, line matting, preparation and roughening up of surfaces.
- Easy deburring work.
- Cleaning vehicle underbodies and for various other work in car body construction.





Diameter (mm)	Centre Diameter (mm)	Max RPM	Art. No.
115	22.23	11100	00585 380 115

LONG LIFE CUTTING DISC FOR STONE



Extremely long service life, optimal cutting capacity in solid and shaped material, very high lateral stability.

- Synthetic resin-bonded, fibrous material-reinforced high-performance cutting discs
- Extremely low susceptibility to breakage
- For free-hand cutting with electric or pneumatic angle grinders

Application Area

Natural stone, artificial stone, sand-lime brick, concrete/reinforced concrete, cutting stone, sheets, prefabricated parts, bricks, tiles, clay pipes, roofing tiles and clinker etc.

Diameter (mm) x Thickness (mm)	Centre Diameter (mm)	Max RPM	Art. No.
230 x 3	22.23	6600	00670 152 303



ZEBRA ALUMINIUM CUTTING DISC



- Synthetic resin-bonded, fibrous material-reinforced high-performance cutting discs
- For free-hand cutting with electric or pneumatic angle grinders
- Extremely low susceptibility to breakage
- Minimal dimension and imbalance tolerances
- Extremely long service life
- Optimal cutting capacity in solid and profile material
- Very high lateral stability

Application Area

Aluminium, aluminium alloys, copper, brass, bronze, other lubricating non-ferrous metals, cutting sprues, solid materials, pipes, profiles and metal sheets etc.

Diameter (mm) x Thickness (mm)	Centre Diameter (mm)	Max RPM	Art. No.
230 x 1.9	22.23	6600	00664 122 301
230 x 2.5	22.23	6600	00670 122 302



DIAMOND CUTTING DISC



Construction Site

The robust diamond cutting disc with high performance values.

- Optimum cutting capacity with long service life.
- High break resistance.
- Meets the maximum safety requirements in accordance with the EN 12413 European standard.
- For use at construction site with changing materials.

Segmented

For dry and wet cutting.

Application area

Old concrete, washed concrete, clinker bricks, interlocking paving stones, concrete piping, poroton bricks.

Diameter (mm)	Centre Diameter (mm)	Segment Thickness (mm)	Max RPM	Art No
115	22.23	1.8	13300	00668 154 115
125	22.23	1.8	12250	00668 154 125
230	22.23	2.4	6650	00668 154 230

REDLINE SEGMENTED DIAMOND BLADE



RED LINE

The robust diamond cutting disc with high performance values.

- Optimum cutting capacity with long service life.
- High break resistance.
- Meets the maximum safety requirements in accordance with the EN 12413 European standard.
- For use at construction site with changing materials.

Turbo

For dry and wet cutting. Quick and clean cut

Application area

Old concrete, washed concrete, clinker bricks, interlocking paving stones, concrete piping, poroton bricks, clay bricks

Diameter (mm)	Centre Diameter (mm)	Segment Thickness (mm)	No. of Segments	Max RPM	Art No
115	22.23	2.2	9	13300	00668 152 115
125	22.23	2.4	10	12250	00668 152 125
230	22.23	2.6	16	6650	00668 152 230

MASONRY PROCESSING



Diamond Chaser Disc 125mm

Wall Chaser 125mm

For use with wall chasing equipment

Art. No. 01688 71



Fachman Diamond Blade 115mm/230mm

Stock bricks, cement pavers, soft cement, green concrete, asphalt, cement blocks

Art. No. 01688 4 - 115mm Fachman

Art. No. 01688 2 - 230mm Fachman



Schneller Diamond Blade 115mm/230mm

Cured concrete, pre-stressed concrete, general masonry, refractory, terrazzo, reinforced concrete, cement pavers, hard clay pavers, facebrick

Art. No. 01688 3 - 115mm Schneller

Art. No. 01688 1 - 230mm Schneller

STEEL PROCESSING

SPEED Cutting 60x2.0mm

Art. No. 00664 100 602

Especially for thin-walled pipes and profiles, thin metal sheets, bodywork panels

Mandrel for 00664 100 602

Art. No. 00664 976



Stainless Steel Cutting 76x1.0mm

Art. No. 00664 130 761



Mandrel for 00664 130 761

Art. No. 00664 978



Flap Wheels

Fine sanding and polishing work in tool and mould construction, working smaller and hard-to-reach surfaces in container and apparatus construction, treating fittings made of heavy and light metals as well as stainless and acid-resistant steels.

Diameters: 30mm, 40mm, 60mm

Grits: P60/P80/P120

Art. No. 00672 010 316/318/311

Art. No. 00672 010 426/428/421

Art. No. 00672 010 646/648/631



Matt Finishing Wheels

Fine sanding and polishing work in tool and mould construction, working smaller and hard-to-reach surfaces in container and apparatus construction, treating fittings made of heavy and light metals as well as stainless and acid-resistant steels

Diameters: (dia X width X shank)

Art. No. 00672 964 218 - 40x20x6

Art. No. 00672 964 318 - 40x30x6

Art. No. 00672 965 318 - 50x30x6



MINI DISC SYSTEM

Nylon Fleece Wheels 50mm/75mm

For removing tempering colour, scale, rust, corrosion, dirt and oxide layers, paint, old brushed-on coatings, synthetic resins, adhesives, gasket residues, cement and concrete residues and for cleaning and machining before and after welding.



Art. No. 00673 22 50 - 50mm

Art. No. 00673 22 75 - 75mm

Art. No. 00586 578 01 - 50mm Backing Pad

Art. No. 00586 578 02 - 75mm Backing Pad

Grinding Pads 50mm/75mm

For machining welding seams, surface sanding, removing lacquer and paint, sharpening tools, dressing and smoothing, deburring, edge and finish machining, de-rusting, especially in hard to reach places

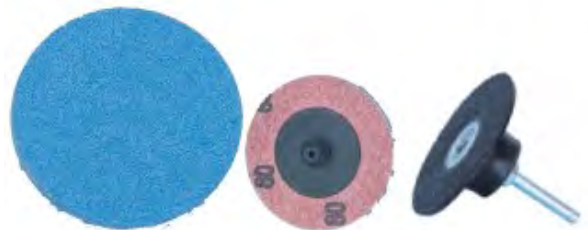

Grits: P40/P60/P80

Art. No. 00580 005 040/060/080 - 50mm

Art. No. 00580 007 540/560/580 - 75mm

Art. No. 00586 578 01 - 50mm Backing Pad

Art. No. 00586 578 02 - 75mm Backing Pa

Mini Fleece Discs 50mm/75mm

For cleaning surfaces, removing tempering colour, rust, dirt and oxide layers, light deburring work, producing decorative surfaces, smoothing welding work without excessive material removal, removing sanding grooves, scratches, coatings and old brushed on coatings.

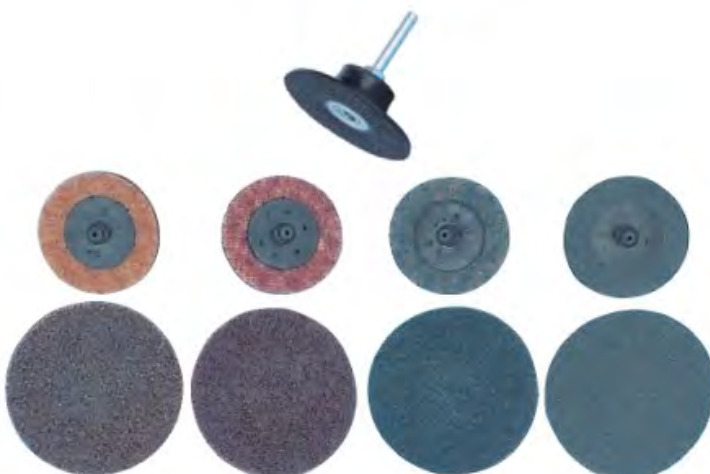

Art. No. 00673 205 010 - 50mm Brown (Coarse)

Art. No. 00673 205 018 - 50mm Red-Brown (Medium)

Art. No. 00673 205 028 - 50mm Blue (Fine)

Art. No. 00673 205 040 - 50mm Grey (Ultra Fine)

Art. No. 00673 207 518 - 75mm Red-Brown (Medium)

Art. No. 00673 207 528 - 75mm Blue (Fine)

Art. No. 00673 207 540 - 75mm Grey (Ultra Fine)

Art. No. 00586 578 01 - 50mm Backing Pad

Art. No. 00586 578 02 - 75mm Backing Pad

MINI DISC SYSTEM

Bristle Disc 50mm

For removing tough, thick and thin deposits such as paint, rust, scale, adhesive areas, gasket residues, coatings or dirt on all types of metal, as well as for cleaning concrete, natural stone, wood and plastic

Art. No. 00673 000 505 - Green G50

Art. No. 00673 000 508 - Yellow G80

Art. No. 00586 578 01 - 50mm Backing Pad



SANDING SPONGES

Thick Sanding Sponges

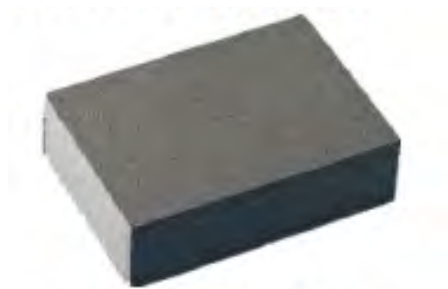

Art. No. 00587 01 ...
(P60/80/100/120/160/220)

Thin Sanding Sponges



Art. No. 00587 02 ... (P60/80/120/160/220)

Features:

- Sandpaper and sanding block in one
- For dry sanding
- Adapts to any shape, making it suitable for universal use
- Can be used repeatedly after rinsing with water



CUP BRUSHES FOR ANGLE GRINDERS

Art. No. 00714 69 01 - 70mm

With-out support ring



BRAIDED CUP BRUSHES (STEEL)

For pre-treating metallic surfaces that must be painted or coated.

Hardened steel wire, braided clockwise

Can be used on all common angle grinders.

Application area

For medium-heavy and heavy rust removal and de-flashing work or for removing slag from welding seams.

Hardened steel wire, braided clockwise

For pre treated metallic surfaces which must be painted or coated.

For use on all commonly available grinders

Art. No. 00714 691 310 - 80mm

With support ring



Art. No. 00993 579 11-100mm

With support ring



* With support ring which is simply removed after free wire has worn down.
Then another 20 mm of wire length is available.

RED PERFECT SANDING DISCS 21 HOLE

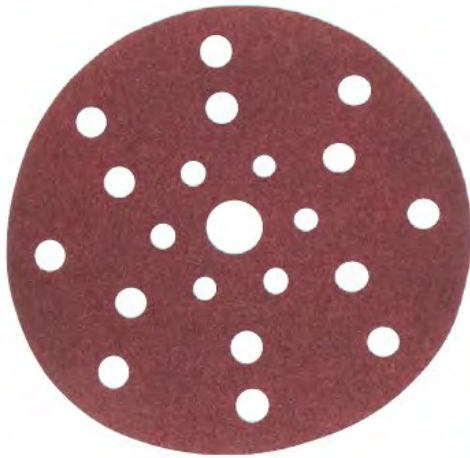

Used to sand fillers, old paints, HS top-coat paints, water-based paints, new-part factory primers, plastic parts and composite fibre materials (e.g. GFRP).

Polyester film backing
Extremely high load capacity of abrasive even at edges, no tearing of the disc, long service life.

Highly aggressive

High degree of material removal

Very homogeneous sanding pattern
Very good paint condition

21-hole pattern
Full-surface extraction, low clogging, long service life

Application Area

Removing dirt and flaws, orange peel effect, trapped dust and paint runs in clear lacquer

Fits all common adhesive plates, e.g. 6-hole, 8-hole and 15-hole plates

Diameter (mm)	Number of Holes	Grit	Art. No.
150	21	800	00581 353 080
150	21	1000	00581 353 100
150	21	1200	00581 353 120
150	21	1500	00581 353 150
150	21	2000	00581 353 200
150	21	2500	00581 353 250

ARIZONA VELCRO DISC

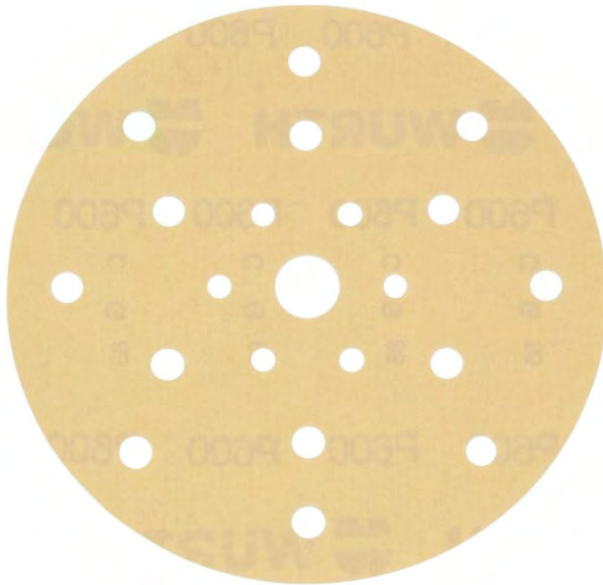

For sanding old paint, fillers, plastics, factory primers on new parts and matting of paintwork.

Up to 20% higher material removal and service life increased by over 90%

- P40-80: Ceramic abrasive grain in the coarse range
- From P220: Newly developed stearate concept

Short sanding time and efficient work

Applications

Grits P40 – P120

Initial sanding of new-part factory primers (KTL paints), sanding off old paint, sanding out stone-chip damage and rusty areas, sanding dented areas down to bare metal, pre-sanding of polyester and fine filler, leveling of filler edges.

Grits P100 – P600

Initial sanding of old paint at the transition to new paint, matting of top-coat paints, sanding of plain paints, thermoplastic acrylic paints, clear lacquers, water-based paints, thick-film, priming, synthetic-resin and nitro fillers, spray filler, 2-component, MS-filler and reaction primers.

Diameter (mm)	Number of Holes	Grit	Art. No.
150	21	40	05506 353 004
150	21	60	05506 353 006
150	21	80	05506 353 008
150	21	100	05506 353 010
150	21	120	05506 353 012
150	21	150	05506 353 015
150	21	180	05506 353 018
150	21	220	05506 353 022
150	21	240	05506 353 024
150	21	320	05506 353 032
150	21	400	05506 353 040
150	21	500	05506 353 050
150	21	600	05506 353 060

RED LINE SANDING DISC

For sanding body filler, colours, plastics, primer filler and varnishes.
High removal rate, long service life and highly flexible.

Applications

- Sanding off of coatings and impurities
- Sanding out of unevenness at the edges of repaired surfaces
- Flattening of body filler and primer filler
- Fine sanding of primer filler
- Keying of old and new varnishes

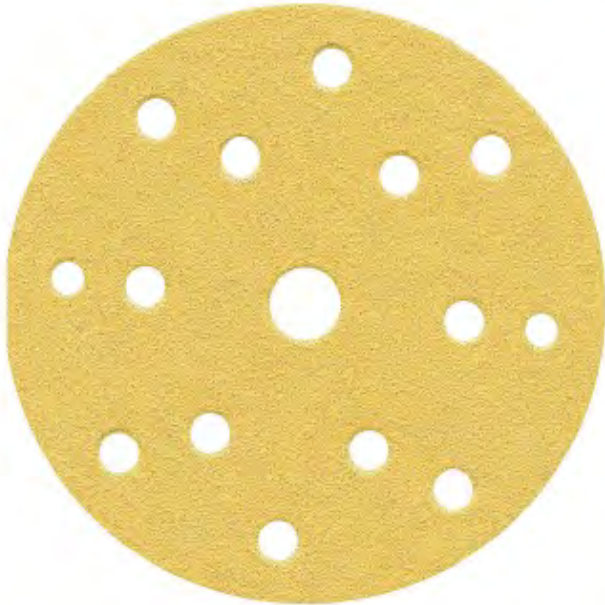

Diameter (mm)	Number of Holes	Grit	Art. No.
150	15	40	00577 363 004
150	15	60	00577 363 006
150	15	80	00577 363 008
150	15	100	00577 363 010
150	15	120	00577 363 012
150	15	150	00577 363 015
150	15	180	00577 363 018
150	15	220	00577 363 022
150	15	240	00577 363 024
150	15	320	00577 363 032
150	15	400	00577 363 040
150	15	500	00577 363 050

NET PERFECT DISC

Net sanding disc for high material removal for sanding plasterboard, hard and soft woods, varnish, fillers, plastics and non-ferrous metals.

Clean working

The open structure of the net sanding disc enables sanding dust to be extracted thoroughly and over the whole area.

Hole-independent

Adapts to any grinding plate

Higher material removal rate as well as a considerably longer service life compared with conventional perforated sanding discs

Net structure

Diameter (mm)	Grit	Art. No.
150mm	P80	05506 393 008
150mm	P100	05506 393 010
150mm	P120	05506 393 012
150mm	P150	05506 393 015
150mm	P180	05506 393 018
150mm	P220	05506 393 022
150mm	P240	05506 393 024
150mm	P320	05506 393 032
150mm	P400	05506 393 040

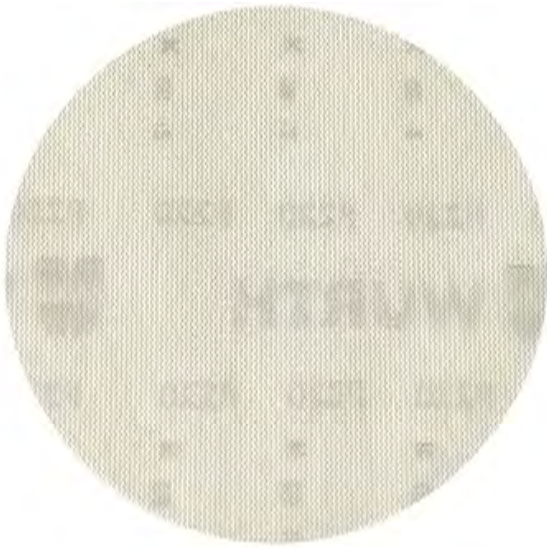

ALUMINIUM OXIDE DISC

Tear-resistant, tough-elastic sanding discs

22mm hole with cross slot

Carrier material made from vulcanised fibre

- Grain size 16-50: 0.8mm
- Grain size 60-120: 0.6mm

Highly elastic fully synthetic resin bonding

Long service life

Electrostatic dispersion

Uniform removal rates

Application Area

For use on hand-held pneumatic or electric angle grinders with circumferential speed of up to 80 m/s in conjunction with a support plate

Edge and surface grinding on flat and curved components

- Grain size 16-40: Levelling welding seams, spot-welding points, brazing seams etc. Deburring work on sheet, cast and forged metal parts. Grinding off sprues.
- Grain size: 40-80: Smoothing off butt welds, edge breakage work and bare grinding of metal sheets and other metal surfaces.
- Grain size 40-120: Rust removal, grinding off old paint layers, fine sanding in vehicle repair

Materials to be processed

Steel, non ferrous metals, cast metal and aluminium alloys

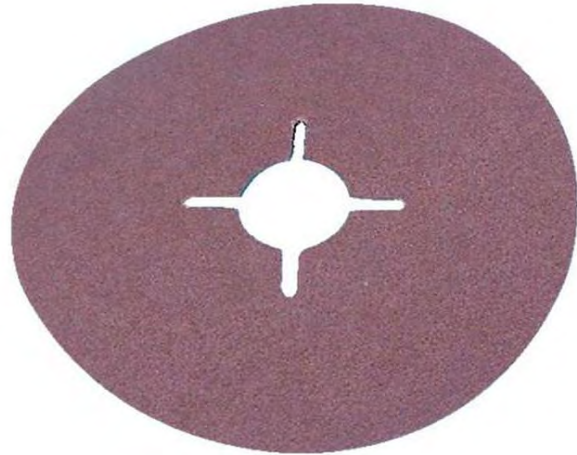

Backing Pads

Art. No. 00586 580 115 - 115mm

Art. No. 00586 580 115 - 125mm

Art. No. 00586 580 115 - 180mm

Diameter (mm)	Grit	Art. No.	Diameter (mm)	Grit	Art. No.
115	16	00580 115 16	125	60	00580 125 60
115	24	00580 115 24	125	80	00580 125 80
115	30	00580 115 30	125	120	00580 125 120
115	36	00580 115 36	180	16	00580 180 16
115	40	00580 115 40	180	24	00580 180 24
115	50	00580 115 50	180	36	00580 180 36
115	60	00580 115 60	180	40	00580 180 40
115	80	00580 115 80	180	60	00580 180 60
115	120	00580 115 120	180	80	00580 180 80
125	24	00580 125 24	180	100	00580 180 100
125	36	0580 125 36	180	120	00580 180 120

ZIRCONIA ALUMINIA DISC (FOR STAINLESS STEEL)

Tear-resistant, tough-elastic sanding discs

22mm hole with cross slot

Carrier material made from vulcanised fibre

- Grain size 16-50: 0.8mm
- Grain size 60-120: 0.6mm

Electrostatic dispersion

Uniform removal rates

Topsize coating (specialised zirconia alumina with cooling multi-bonding and grinding fillers) and highly elastic fully synthetic resin bonding

Aggressive grinding performance

Cool grinding-no tarnishing of the workplace

Long service life

Low noise levels

Effective self-sharpening effect of the grinding grain

Application Area

For use on hand-held pneumatic or electric angle grinders with circumferential speed of up to 80 m/s in conjunction with a support plate

Edge and surface grinding on flat and curved components

- Grain size 16-40: Levelling welding seams, spot-welding points, brazing seams etc. Deburring work on sheet, cast and forged metal parts. Grinding off sprues.
- Grain size: 40-80: Smoothing off butt welds, edge breakage work and bare grinding of metal sheets and other metal surfaces.
- Grain size 40-120: Rust removal, grinding off old paint layers, fine sanding in vehicle repair

Materials to be processed

Corrosion resistant and highly heat-resistant steels (stainless steel), carbon steels, forged steel, non-ferrous metals, chrome and nickel alloys and grey cast iron

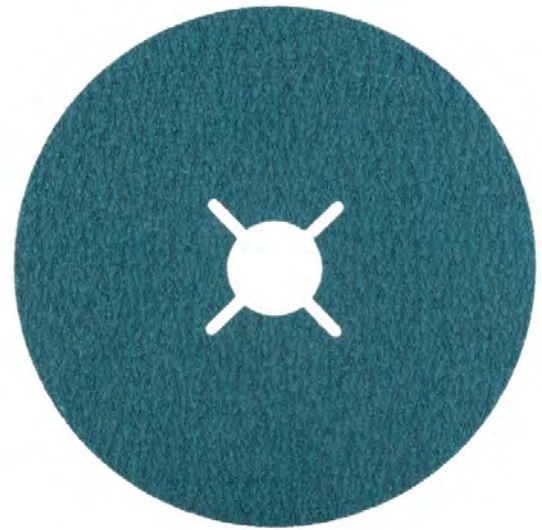

Art. No. 00586 580 115

Diameter (mm)	Grit	Art. No.
115	40	00580 511 540
115	60	00580 511 560
115	80	00580 511 580
115	120	00580 511 512

ZEBRA SANDING BELT KGX



Width x length (mm)	Grit	Art. No.
75 x 533	40	00675 040 533
75 x 533	60	00675 060 533
75 x 533	80	00675 080 533
75 x 533	100	00675 100 533
75 x 533	120	00675 120 533
75 x 533	150	00675 150 533
100 x 610	40	00675 040 610
100 x 610	60	00675 060 610
100 x 610	80	00675 080 610
100 x 610	100	00675 100 610
100 x 610	120	00675 120 610
100 x 610	150	00675 150 610

For woodworking and metalworking

For hand sanders

Aggressive abrasive grain for

Maximum material removal

Minimal clogging

Long service life

Uniform grinding

Design:

X-fabric

Aluminium oxide (corundum)

Synthetic resin bond

Special wave shaped closure

Sanding Belt Cleaner

For effective cleaning of sanding belts

Art. No. 01675 001



ZEBRA EMERY CLOTH

Light weight cloth sanding strips used for hand sanding in many applications. Suitable for fitting work: used to ensure a perfect fit of steel parts where final adjustment is needed. Used for cleaning, as a means of removing rust from polished components.

Art. No. 00674 830...30mm (Grits: 60, 80, 120, 180)

Art. No. 00674 840...40mm (Grits: 60/80/120/180)

Art. No. 00674 850...50mm (Grits: 60, 80, 120, 400)



FLEECE PADS/ ROLLS

Coarse and aggressive: Removes rust, rust film, and surface soiling. For roughening old paint, varnish, plastics, rubber parts (e. g. prior to bonding).

Medium / medium fine: Universally applicable to remove rust film, light soiling, discolouration; for rubbing down ground or brushed surfaces or for degreasing and cleaning prior to painting.

Fine / ultra fine: For cleaning delicate surfaces, for repairing light scratches on metals. Also suitable for applying fine / very fine matt finishes to steels and non-ferrous metals

Art. No. 01585 44... Pads

150mmx225mm

Coarse, Med, Fine, General Purpose, Very Fine, Super Fine



Art. No. 01585 805... Rolls

150mmx10Mtr

Coarse, Med, Fine, General Purpose

ABRASIVE ROLLS

Production Paper

For dry sanding of body fillers

Art. No. 01574 70 36/60/80/120 (Grits: 36, 60, 80, 120)



Yellow Abrasive Paper

For machining veneers and solid wood. Sanding edges, rims and flat parts. For hand and machine use.

Removes material quickly.



Art. No. 01581 18...

(P40/60/80/100/120/150/180/240/320)



Grey Carat Paper

High-grade abrasive paper for hand sanding, especially for wood; the fine grains are also suitable for softer varnishes such as water varnish. High sanding performance and durability due to synthetic resin bond.

Art. No. 01582 01...

(G150/180/220/240/320/400)



Wood KP Perfect Dry Abrasive Paper Roll

Dry abrasive paper for pre-sanding of untreated soft and hardwoods, MDF, OSB (oriented strand board) and veneered panels and plywood

Art. No. 00583 115... KPE Rolls

(Grid P40/60/80/100/120/150/180)

KPE Quality (corundum paper E).

- Grain 40-100 discs and sheets 40-150 rolls.
- Paper weight/m² = 200-250 gr. = E paper.
- Synthetic resin bond.
- Aluminium oxide (special fused corundum)



Art. No. 00583 215...KPC Rolls

(Grid P40/60/80/100/120/150/180)

KPC Quality (corundum paper C).

- Grain 120-280 discs, sheets and rolls.
- Paper weight/m² = 105-115 gr. = C paper.
- Synthetic resin bond.
- Aluminium oxide (special fused alumina)

WATERPROOF ABRASIVE PAPER



Application

May be used without soaking, extremely flexible backing.

Precise working on contours.

Excellent finish.

Excellent contact to the material and extremely good grip.

Very good initial and long-term abrasive action with a long service life.

Sanding of resin -, nitro - and thermoplastic acryl lacquer constructions.

Sanding of conventional fillers (P400 - P800).

Correcting paint coat imperfections (P1000 - P2000), removal of imbed - dust and dirt particles (P2000).

Base Material	Latex C paper
Bond	Synthetic resin
Abrasive Material	Silicone carbide
Scattering	Closed scattering
Colour	Black
Available Grits	P100-P2000
Form	Sheet

Length x width (mm)	Grit	Art. No.
280 x 230	100	00584 11 100
280 x 230	180	00584 11 180
280 x 230	220	00584 11 220
280 x 230	280	00584 11 280
280 x 230	320	00584 11 320
280 x 230	360	00584 11 360
280 x 230	400	00584 11 400
280 x 230	600	00584 11 600
280 x 230	800	00584 11 800
280 x 230	1000	00584 111 000
280 x 230	1200	00584 111 200
280 x 230	1500	00584 111 500
280 x 230	2000	00584 112 000





SAWING

CIRCULAR SAW BLADES



RED LINE

Versatile timber cutting saw blades with thin kerf design.

- Ideal for timber cutting.
- Fast, smooth and clean cutting for less feed pressure & less material waste.
- Alternating carbide tooth design (AT).
- For lengthwise and cross cuts.
- Can be used on circular, mitre and drop saws.

Dimension in mm (dia. x thickness x bore)	No. of teeth	Max. rpm	Art. No.
185 x 1.8/1.2 x 20/16	40AT	8.250	05523 801 184

BRUSHES

Wire Brush



Art. No. 00697 4 - 4 Rows

Art. No. 00697 5 - 5 Rows

File brush



Art. No. 00714 61 67

Technical information Documents

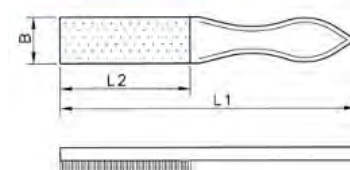

Length (L1)	260 mm
Length of head (L 2)	115 mm
Width (B)	40 mm

ZEBRA HSS BI-METAL HACKSAW BLADE

No saw blade offers more cutting performance and flexibility.

- Special steels: High-alloyed high-speed steel on tooth edge, tough tool steel on backing.
- State-of-the-art production techniques guarantee unsurpassed quality and precision.
- The welded connections are produced with electron beams in a high vacuum.
- Thanks to tooth edges of fully hardened material, cutting performance and service life are unbeatable.
- You work with one saw blade faster, longer and more economically.

Normal toothing

- More economical
- Safer
- High cutting performance
- Longer service life

Progressive toothing

Clear advantages thanks to different tooth pitches:

- All-purpose blade
- High tooth pitch in area of start of cut enables easy start of sawing. "Fluttering" of thin materials is considerably reduced.
- Low tooth pitch in remaining cutting area enables high cutting performance.

Use

- Tool steel (high- and low-alloyed)
- Structural steel (high- and low-alloyed)
- High-speed steel
- Stainless steel

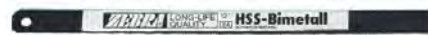

Teeth per Inch	Length (mm)	Width (mm)	Thickness (mm)	Art. No.
24	300	12.5	0.63	00603 300 13
32	300	12.5	0.63	00603 300 133
18-32	300	13.0	0.65	00603 301 13

Hacksaw Frame

Art. No. 00714 64 02



Junior Frame

Art. No. 00609 1



Junior Hacksaw Blades

All purpose blade, suited to steel

Art. No. 00609 2 - 32TPi



JIGSAW BLADES

High-performance saw blades

High cutting performance and long service life

- *** High-performance saw blade for extremely demanding applications, high cutting capacity and long service life.
- ** Excellent saw blade for meeting tough requirements.
- * Excellent standard blade for conventional applications

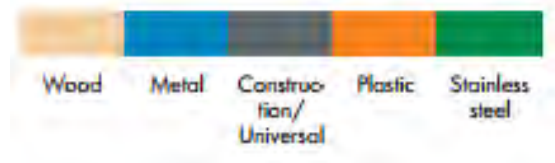

Jig Saw Blade Hardwood Up-Cut

Art. No. 00608 115 90



Jig Saw Blade for Aluminium Up-Cut

Art. No. 00608 116 008



Jig Saw Blade Hardwood Up-Cut

Art. No. 00608 115 92



Jig Saw Blade for Glass/Fibreglass

Art. No. 00608 115 95

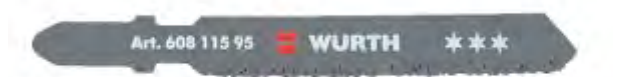

Jig Saw Blade for Hard and Soft Wood

Art. No. 00608 116 100



Jig Saw Blade for Plywood/PVC Plastic

Art. No. 00608 116 112



Jig Saw Blade for Wood (Nails) (Bi-Metal)

Art. No. 00615 050 25



Jig Saw Blade for Laminate/Ply (Bi-Metal)

Art. No. 00615 075 25



Jig Saw Blade for Plywood/plaster Fibreboard

Art. No. 00608 116 111



JIGSAW BLADES

Cooling extends the life of Wurth compass saw blades

Material to be processed	Coolant
Soft steel, stainless steels, nonferrous metals	Drilling and cutting oil, Art. No. 0893 050
Aluminum, aluminum alloys	Turpentine, kerosene or a turpentine-kerosene mixture
Eternit, laminate, molded materials, plexiglass, plastic, insulating materials, rubber	Water (Important: avoid all contact with electrical parts).

Notice

High mechanical and thermal loads reduce the service life of the blade

Cooling lengthens the service life of jigsaw blades

Jig Saw Blade for various Metals

Art. No. 00608 116 104



Jig Saw Blade for Thin Metal (Bi-Metal)

Art. No. 00615 050 20



Jig Saw Blade for Non-Ferrous (Bi-Metal)

Art. No. 00615 050 15



Jig Saw Blade for Stainless Steel (Bi-Metal)

Art. No. 00615 250 14



Jig Saw Blade for Stainless Steel A2

Art. No. 00608 115 93



Jig Saw Blade Universal

Art. No. 00608 116 345



Jig Saw Blade for Alu / Non Ferrous

Art. No. 00615 075 30



Jig Saw Blade for Thin Steel 105mm

Art. No. 00608 116 106



Jig Saw Blade for Thick Steel 110mm

Art. No. 00608 116 105

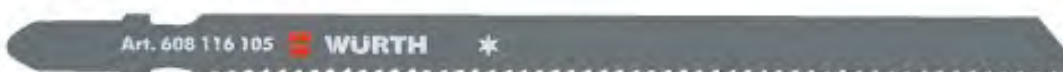

SABER SAW BLADES

- *** High-performance saw blade for extremely demanding applications, high cutting capacity and long tool life.
- ** Excellent blade for harder use.
- * Excellent standard blade for conventional applications.

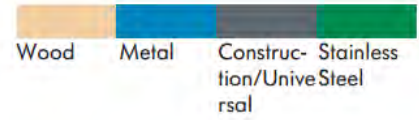

Sabre Saw Blade for Wood 150mm
Art. No. 00608 030 22



Sabre Saw Blade for Insulation 300mm
Art. No. 00615 730 010



Sabre Saw Blade for Metal 100mm
Art. No. 00615 910 014



Sabre Saw Blade for Metal 150mm
Art. No. 00615 915 010

How to read the packaging

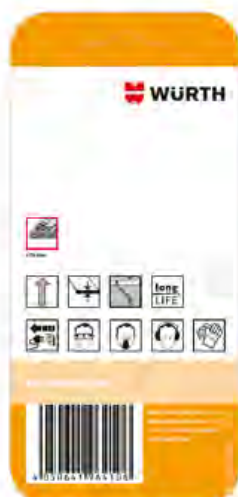

<20 mm
Plastics,
pipes,
profiles



Straight cut



Thin material



Type of cut -
Straight, fine



Long life time



Remove tool
from the
power plug
when not in
use



Use eye
protection



Wear a dust
mask



Use ear
protection



Use gloves

BI METAL HSCO SAW

Steel/Stainless steel. Extremely fast drilling speed and long service life, even on stainless steel solid materials



Extremely fast sawing progress with minimal effort

Newly-developed tooth shape

Instructions

Start drilling with low drilling force.
Continue drilling with reduced, even pressure.
Avoid oscillating movements when drilling, always observe speed table, use coolant.
"Ventilate" hole saw when used on wood and

Notice

Always keep to the speed values. Excessive rotation speeds will blunt the teeth and thus make the cylinder saw unusable.
For regular use on steel and stainless steel, we recommend our HW-equipped hole

Individual

Art. No. 00632 900 ...

Set

Art. No. 05964 063 291



Art No.	Size
00632 900 035	HSSCO BI- MET HOLE SAW BLACK 35MM
00632 900 038	HSSCO BI- MET HOLE SAW BLACK 38MM
00632 900 040	HSSCO BI- MET HOLE SAW BLACK 40MM
00632 900 044	HSSCO BI- MET HOLE SAW BLACK 44MM
00632 900 046	HSSCO BI- MET HOLE SAW BLACK 46MM
00632 900 048	HSSCO BI- MET HOLE SAW BLACK 48MM
00632 900 051	HSSCO BI- MET HOLE SAW BLACK 51MM
00632 900 057	HSSCO BI- MET HOLE SAW BLACK 57MM
00632 900 064	HSSCO BI- MET HOLE SAW BLACK 64MM
00632 900 089	HSSCO BI- MET HOLE SAW BLACK 89MM
00632 98	HSSCO BI- MET HOLE SAW BLACK 98MM



B2000 BI - METAL HOLE SAW

- Quick and clean cut thanks to the HSS bi-metal construction.
- For use in all steel materials, including cast metal, copper, bronze, aluminium, plastics and wood.
- No. of teeth 6/inch, cutting depth: 32 mm.



Pilot Drill for Hole Saw

Art. No. 00632 014 - for 00632 02

Art. No. 00632 014 1 - for 00632 04



Cutter Holder for Hole Saw

Art. No. 00632 02 - 32 to 152mm

Art. No. 00632 04 - 14 to 29mm

Art. No.	Size	Art. No.	Size
00632 19	B2000 HSS Bi-Met Hole saw 19MM	00632 44	B2000 HSS Bi-Met Hole saw 44MM
00632 20	B2000 HSS Bi-Met Hole saw 20MM	00632 46	B2000 HSS Bi-Met Hole saw 46MM
00632 21	B2000 HSS Bi-Met Hole saw 21MM	00632 48	B2000 HSS Bi-Met Hole saw 48MM
00632 22	B2000 HSS Bi-Met Hole saw 22MM	00632 51	B2000 HSS Bi-Met Hole saw 51MM
00632 25	B2000 HSS Bi-Met Hole saw 25MM	00632 52	B2000 HSS Bi-Met Hole saw 52MM
00632 27	B2000 HSS Bi-Met Hole saw 27MM	00632 54	B2000 HSS Bi-Met Hole saw 54MM
00632 30	B2000 HSS Bi-Met Hole saw 30MM	00632 57	B2000 HSS Bi-Met Hole saw 57MM
00632 32	B2000 HSS Bi-Met Hole saw 32MM	00632 64	B2000 HSS Bi-Met Hole saw 64MM
00632 35	B2000 HSS Bi-Met Hole saw 35MM	00632 65	B2000 HSS Bi-Met Hole saw 65MM
00632 38	B2000 HSS Bi-Met Hole saw 38MM	00632 67	B2000 HSS Bi-Met Hole saw 67MM
00632 40	B2000 HSS Bi-Met Hole saw 40MM	00632 76	B2000 HSS Bi-Met Hole saw 76MM
00632 41	B2000 HSS Bi-Met Hole saw 41MM	00632 83	B2000 HSS Bi-Met Hole saw 83MM
00632 43	B2000 HSS Bi-Met Hole saw 43MM	00632 89	B2000 HSS Bi-Met Hole saw 89MM



Contact detail

JOHANNESBURG - HEADOFFICE

PLUMBAGO BUSINESS PARK, SPIER
ROAD, GLEN ERASMIA X17, KEMPTON PARK,
TEL : +27 11 281 1000
EMAIL : wurthsa@wurth.co.za

CAPE TOWN

UNIT 2, 4 DAWN STREET, MONTAGUE GARDEN-
SCAPE TOWN,
TEL: +27 21 552 7760
EMAIL : marisa@wurth.co.za

PORT ELIZABETH

31 UITENHAGE ROAD, SYDENHAM
PORT ELIZABETH,
TEL: +27 41 365 7360
EMAIL : pe@wurth.co.za

GEORGE

CNR BRICK & FOUNDRY ROAD,
GEORGE INDUSTRIAL ,
TEL : +27 44 874 6006
EMAIL : george@wurth.co.za

DURBAN

NO 139 JOSIAH GUMEDE ROAD
(OLD MAIN ROAD)
CNR MASON STREET, PINETOWN,
TEL: +27 31 701 6900
EMAIL : gerhard@wurth.co.za

BLOEMFONTEIN

GENERAAL HERTZOG AVENUE, 1ST FLOOR,
PRELLER WALKBLOEMFONTEIN,
TEL: +27 51 430 5514
EMAIL: group18@wurth.co.za